

MM54HC73/MM74HC73 Dual J-K Flip-Flops with Clear

General Description

These J-K Flip-Flops utilize advanced silicon-gate CMOS technology. They possess the high noise immunity and low power dissipation of standard CMOS integrated circuits. These devices can drive 10 LS-TTL loads.

These flip-flops are edge sensitive to the clock input and change state on the negative going transition of the clock pulse. Each one has independent, J, K, CLOCK, and CLEAR inputs and Q and \bar{Q} outputs. CLEAR is independent of the clock and accomplished by a low level on the input.

The 54HC/74HC logic family is functionally as well as pin-out compatible with the standard 54LS/74LS logic family.

All inputs are protected from damage due to static discharge by internal diode clamps to V_{CC} and ground.

Features

- Typical propagation delay: 16 ns
- Wide operating voltage range: 2–6V
- Low input current: 1 μ A maximum
- Low quiescent current: 40 μ A (74HC Series)
- High output drive: 10 LS-TTL loads

Connection and Logic Diagrams

Truth Table

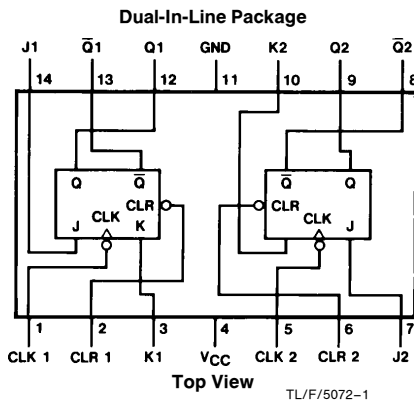

Inputs				Outputs	
CLR	CLK	J	K	Q	\bar{Q}
L	X	X	X	L	H
H	↓	L	L	Q0	$\bar{Q}0$
H	↓	H	L	H	L
H	↓	L	H	L	H
H	↓	H	H	TOGGLE	TOGGLE
H	H	X	X	Q0	$\bar{Q}0$

Order Number MM54HC73 or MM74HC73

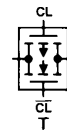
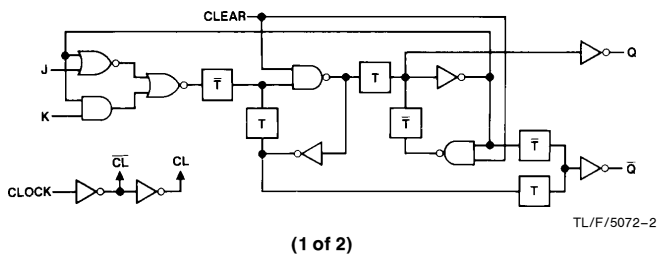

Absolute Maximum Ratings (Notes 1 & 2)

If Military/Aerospace specified devices are required, please contact the National Semiconductor Sales Office/Distributors for availability and specifications.

Supply Voltage (V_{CC})	-0.5 to +7.0V
DC Input Voltage (V_{IN})	-1.5 to $V_{CC} + 1.5V$
DC Output Voltage (V_{OUT})	-0.5 to $V_{CC} + 0.5V$
Clamp Diode Current (I_{IK}, I_{OK})	± 20 mA
DC Output Current, per pin (I_{OUT})	± 25 mA
DC V_{CC} or GND Current, per pin (I_{CC})	± 50 mA
Storage Temperature Range (T_{STG})	-65°C to +150°C
Power Dissipation (P_D) (Note 3)	600 mW
S.O. Package only	500 mW
Lead Temperature (T_L) (Soldering 10 seconds)	260°C

Operating Conditions

	Min	Max	Units
Supply Voltage (V_{CC})	2	6	V
DC Input or Output Voltage (V_{IN}, V_{OUT})	0	V_{CC}	V
Operating Temp. Range (T_A)			
MM74HC	-40	+85	°C
MM54HC	-55	+125	°C
Input Rise or Fall Times (t_r, t_f)			
$V_{CC} = 2.0V$		1000	ns
$V_{CC} = 4.5V$		500	ns
$V_{CC} = 6.0V$		400	ns

DC Electrical Characteristics (Note 4)

Symbol	Parameter	Conditions	V_{CC}	$T_A = 25^\circ C$			Units	
				Typ	74HC $T_A = -40$ to $85^\circ C$	54HC $T_A = -55$ to $125^\circ C$		
V_{IH}	Minimum High Level Input Voltage		2.0V		1.5	1.5	V	
			4.5V		3.15	3.15	V	
			6.0V		4.2	4.2	V	
V_{IL}	Maximum Low Level Input Voltage**		2.0V		0.5	0.5	V	
			4.5V		1.35	1.35	V	
			6.0V		1.8	1.8	V	
V_{OH}	Minimum High Level Output Voltage	$V_{IN} = V_{IH}$ or V_{IL} $ I_{OUT} \leq 20 \mu A$	2.0V	2.0	1.9	1.9	V	
			4.5V	4.5	4.4	4.4	V	
			6.0V	6.0	5.9	5.9	V	
		$V_{IN} = V_{IH}$ or V_{IL} $ I_{OUT} \leq 4.0$ mA $ I_{OUT} \leq 5.2$ mA	4.5V	4.2	3.98	3.84	3.7	V
			6.0V	5.7	5.48	5.34	5.2	V
V_{OL}	Maximum Low Level Output Voltage	$V_{IN} = V_{IH}$ or V_{IL} $ I_{OUT} \leq 20 \mu A$	2.0V	0	0.1	0.1	V	
			4.5V	0	0.1	0.1	V	
			6.0V	0	0.1	0.1	V	
		$V_{IN} = V_{IH}$ or V_{IL} $ I_{OUT} \leq 4.0$ mA $ I_{OUT} \leq 5.2$ mA	4.5V	0.2	0.26	0.33	0.4	V
			6.0V	0.2	0.26	0.33	0.4	V
I_{IN}	Maximum Input Current	$V_{IN} = V_{CC}$ or GND	6.0V		± 0.1	± 1.0	μA	
I_{CC}	Maximum Quiescent Supply Current	$V_{IN} = V_{CC}$ or GND $I_{OUT} = 0 \mu A$	6.0V		4.0	40	μA	

Note 1: Absolute Maximum Ratings are those values beyond which damage to the device may occur.

Note 2: Unless otherwise specified all voltages are referenced to ground.

Note 3: Power Dissipation temperature derating — plastic "N" package: -12 mW/°C from 65°C to 85°C; ceramic "J" package: -12 mW/°C from 100°C to 125°C.

Note 4: For a power supply of $5V \pm 10\%$ the worst case output voltages (V_{OH} , and V_{OL}) occur for HC at 4.5V. Thus the 4.5V values should be used when designing with this supply. Worst case V_{IH} and V_{IL} occur at $V_{CC} = 5.5V$ and 4.5V respectively. (The V_{IH} value at 5.5V is 3.85V.) The worst case leakage current (I_{IN} , I_{CC} , and I_{OZ}) occur for CMOS at the higher voltage and so the 6.0V values should be used.

** V_{IL} limits are currently tested at 20% of V_{CC} . The above V_{IL} specification (30% of V_{CC}) will be implemented no later than Q1, CY'89.

AC Electrical Characteristics $V_{CC} = 5V, T_A = 25^\circ C, C_L = 15 pF, t_r = t_f = 6 ns$

Symbol	Parameter	Conditions	Typ	Guaranteed Limit	Units
f_{MAX}	Maximum Operating Frequency		50	30	MHz
t_{PHL}, t_{PLH}	Maximum Propagation Delay Clock to Q or \bar{Q}		16	21	ns
t_{PHL}, t_{PLH}	Maximum Propagation Delay Clear to Q or \bar{Q}		21	26	ns
t_{REM}	Minimum Removal Time, Clear to Clock		10	20	ns
t_S	Minimum Setup Time, J or K to Clock		14	20	ns
t_H	Minimum Hold Time J or K to Clock		-3	0	ns
t_W	Minimum Pulse Width, Clock or Clear		10	16	ns

AC Electrical Characteristics $C_L = 50 pF, t_r = t_f = 6 ns$ (unless otherwise specified)

Symbol	Parameter	Conditions	V_{CC}	$T_A = 25^\circ C$		$74HC$	$54HC$	Units
						$T_A = -40 to 85^\circ C$	$T_A = -55 to 125^\circ C$	
				Typ	Guaranteed Limits			
f_{MAX}	Maximum Operating Frequency		2.0V	9	5	4	3	MHz
			4.5V	45	27	21	18	MHz
			6.0V	53	32	25	21	MHz
t_{PHL}, t_{PLH}	Maximum Propagation Delay Clock to Q or \bar{Q}		2.0V	70	126	160	185	ns
			4.5V	18	25	32	37	ns
			6.0V	15	21	27	32	ns
t_{PHL}, t_{PLH}	Maximum Propagation Delay Clear to Q or \bar{Q}		2.0V	126	155	194	250	ns
			4.5V	25	31	39	47	ns
			6.0V	21	26	32	40	ns
t_{REM}	Minimum Removal Time Clear to Clock		2.0V	55	100	125	150	ns
			4.5V	11	20	25	30	ns
			6.0V	9	17	21	25	ns
t_S	Minimum Setup Time J or K to Clock		2.0V	77	100	125	150	ns
			4.5V	15.4	20	25	30	ns
			6.0V	13	17	21	25	ns
t_H	Minimum Hold Time J or K from Clock		2.0V	-3	0	0	0	ns
			4.5V	-3	0	0	0	ns
			6.0V	-3	0	0	0	ns
t_W	Minimum Pulse Width Clock or Clear		2.0V	55	80	100	120	ns
			4.5V	11	16	20	24	ns
			6.0V	9	14	18	21	ns
t_{TLH}, t_{THL}	Maximum Output Rise and Fall Time		2.0V	30	75	95	110	ns
			4.5V	8	15	19	22	ns
			6.0V	7	13	16	19	ns
t_r, t_f	Maximum Input Rise and Fall Time		2.0V		1000	1000	1000	ns
			4.5V		500	500	500	ns
			6.0V		400	400	400	ns
C_{PD}	Power Dissipation Capacitance (Note 5)	(per flip-flop)		80				pF
C_{IN}	Maximum Input Capacitance			5	10	10	10	pF

Note 5: C_{PD} determines the no load dynamic power consumption, $P_D = C_{PD} V_{CC}^2 f + I_{CC} V_{CC}$, and the no load dynamic current consumption, $I_S = C_{PD} V_{CC} f + I_{CC}$.

Typical Applications

N Bit Binary Ripple Counter with Enable and Reset

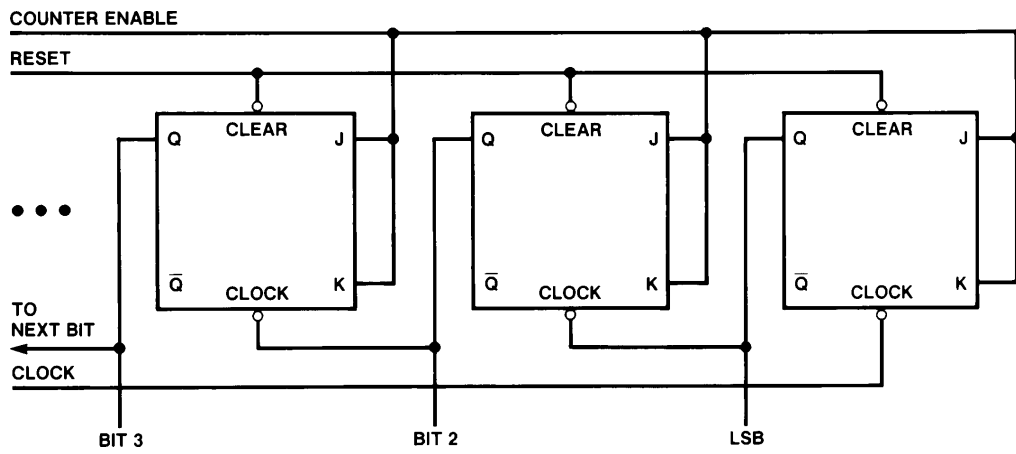

TL/F/5072-4

N Bit Shift Register with Clear

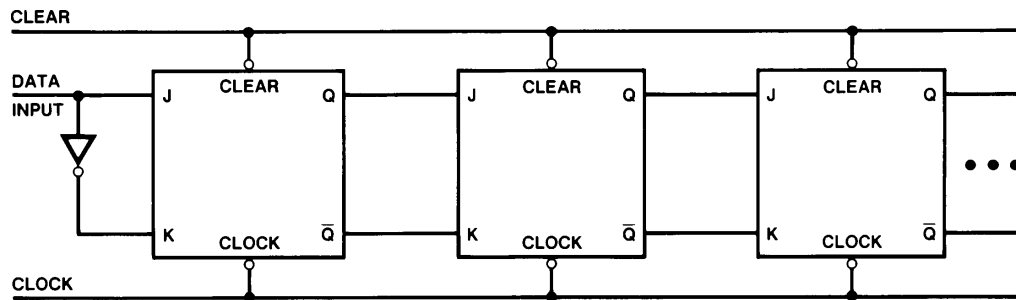

TL/F/5072-5



Physical Dimensions inches (millimeters)

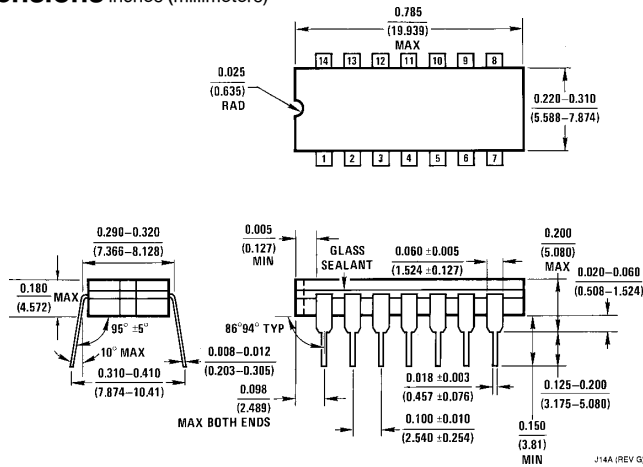

Dual-In Line Package (J)
Order Number MM54HC73J or MM74HC73J
NS Package J14A

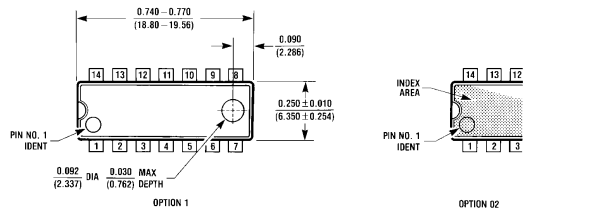

Dual-In Line Package (N)
Order Number MM74HC73N
NS Package N14A

LIFE SUPPORT POLICY

NATIONAL'S PRODUCTS ARE NOT AUTHORIZED FOR USE AS CRITICAL COMPONENTS IN LIFE SUPPORT DEVICES OR SYSTEMS WITHOUT THE EXPRESS WRITTEN APPROVAL OF THE PRESIDENT OF NATIONAL SEMICONDUCTOR CORPORATION. As used herein:

1. Life support devices or systems are devices or systems which, (a) are intended for surgical implant into the body, or (b) support or sustain life, and whose failure to perform, when properly used in accordance with instructions for use provided in the labeling, can be reasonably expected to result in a significant injury to the user.
2. A critical component is any component of a life support device or system whose failure to perform can be reasonably expected to cause the failure of the life support device or system, or to affect its safety or effectiveness.

 <p>National Semiconductor Corporation 1111 West Bardin Road Arlington, TX 76017 Tel: 1(800) 272-9959 Fax: 1(800) 737-7018</p>	<p>National Semiconductor Europe Fax: (+49) 0-180-530 85 86 Email: cnjwge@tevm2.nsc.com Deutsch Tel: (+49) 0-180-530 85 85 English Tel: (+49) 0-180-532 78 32 Français Tel: (+49) 0-180-532 93 58 Italiano Tel: (+49) 0-180-534 16 80</p>	<p>National Semiconductor Hong Kong Ltd. 19th Floor, Straight Block, Ocean Centre, 5 Canton Rd. Tsimshatsui, Kowloon Hong Kong Tel: (852) 2737-1600 Fax: (852) 2736-9960</p>	<p>National Semiconductor Japan Ltd. Tel: 81-043-299-2309 Fax: 81-043-299-2408</p>
--	--	---	---

National does not assume any responsibility for use of any circuitry described, no circuit patent licenses are implied and National reserves the right at any time without notice to change said circuitry and specifications.