

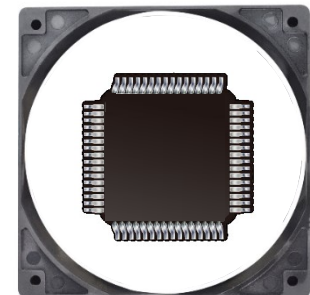

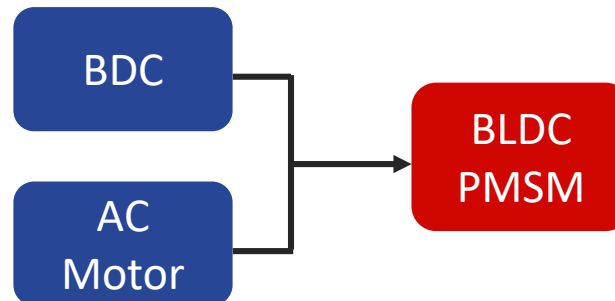

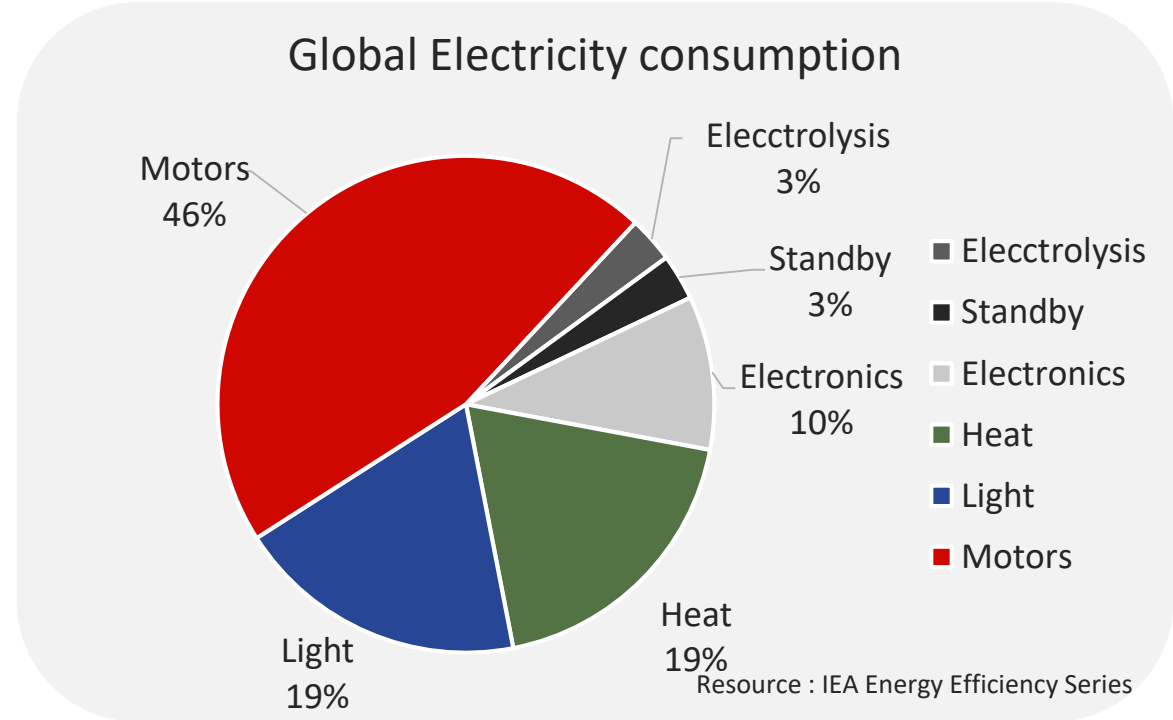

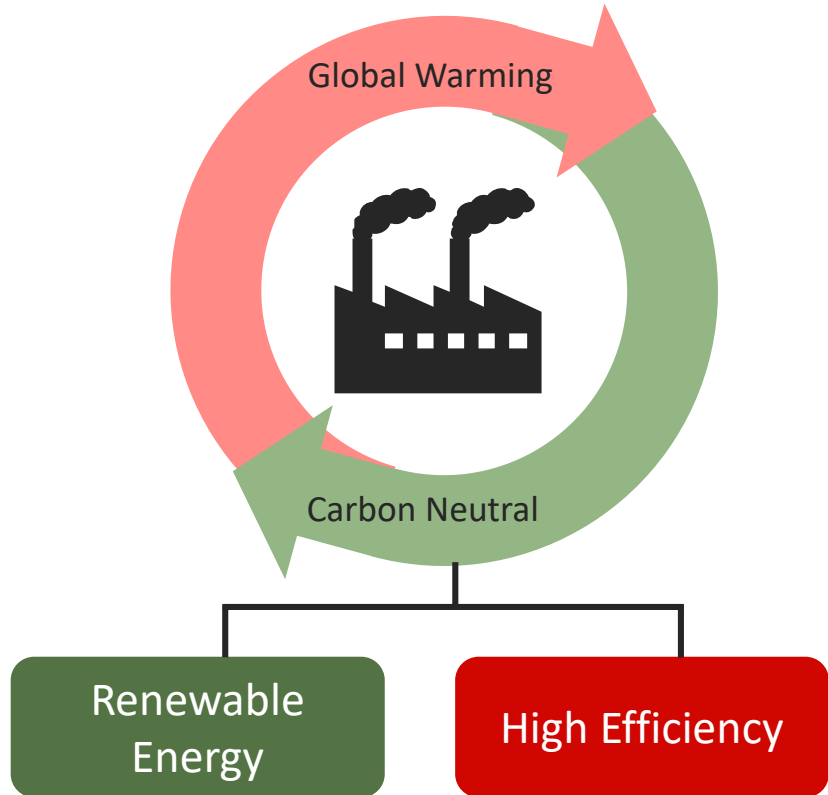













Motor Application Market Trend



NM MCU Series Product Roadmap

128k B	NM1530	Cortex-M0, HDIV, -40~105°C, 2.5V~5.5V, HIRC 1%@25°C, 16-bit PWM, 24-bit Timer, 12/10-bit ADC, UART, ACMP	LQFP48 _(7x7mm²) LQFP64 _(10x10mm²) LQFP100 _(14x14mm²)	CAN2.0b/MDU/ OPA x 2/QEI/2 motors compatible 72MHz, 8kB/16kB RAM, I ² C x 1, SPI x 3, ECAP	 
64 kB	NM1234		LQFP48 _(7x7mm²)	72MHz/OPA x 3/PGA x1/DAC x 2 /QEI 8kB/16kB RAM, I ² C x 3, SPI x 2 , ECAP	  
	NM1244		QFN48 _(7x7mm²) LQFP48 _(7x7mm²)	60MHz/Standby < 1μA/ DAC x 2/DMA 8kB RAM, I ² C x 2, SPI x 1, ECAP , OPA x 1	   
29.5 kB	NM1120		QFN20 _(4x4mm²) TSSOP20 _(4.4x6.5mm²) TSSOP28 _(4.4x9.7mm²)	48MHz/PGA x 1 4kB RAM, I ² C x 2, SPI x 2, ECAP	   
17.5 kB	NM1200		QFN33 _(5x5mm²) LQFP48 _(7x7mm²)	48MHz 2kB RAM, I ² C x 1, SPI x 1	   
	NM1100	TSSOP20 _(4.4x6.5mm²)	48MHz 2kB RAM	 	

Selection Guide for MCU Series

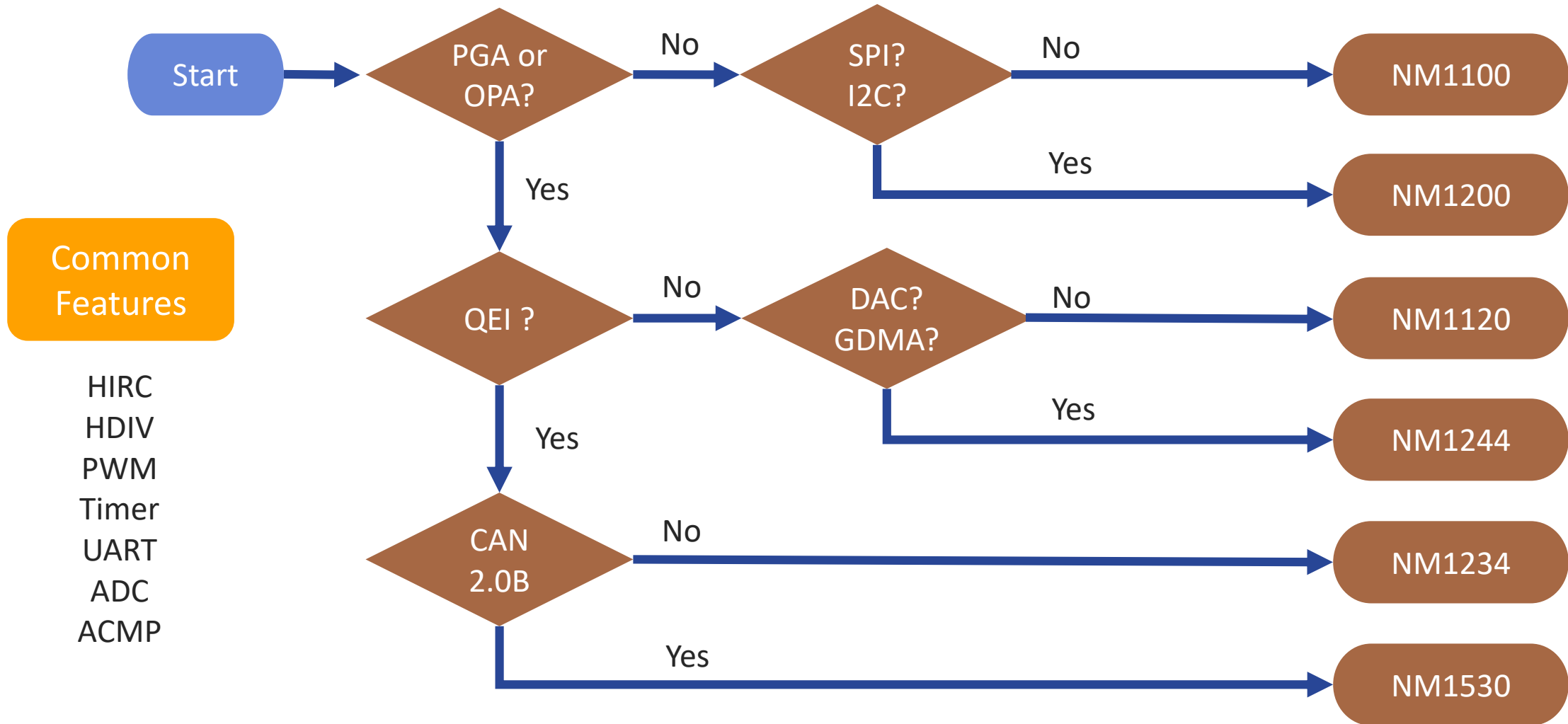

NM MCP Series Product Roadmap

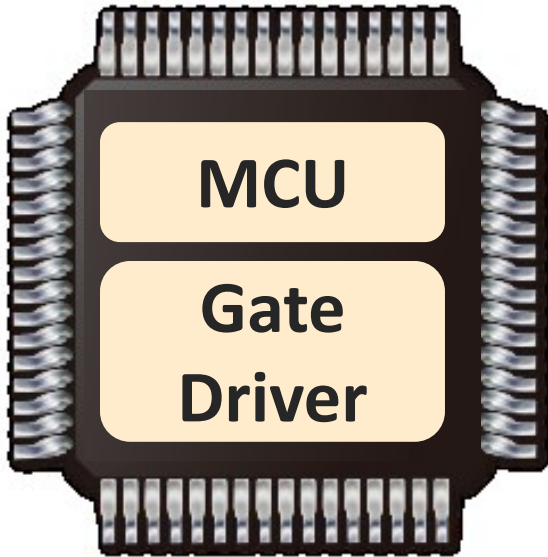

Built-in functions:

- 5V LDO
- Comparators
- Shoot-through protection
- Thermal protection
- UVLO

	600V		NM1817 LQFP44(10x10)	
	200V			NM18440 LQFP48(7x7)
	40V	NM18002 QFN24(4x4)	NM18107 QFN32(5x5)	
MCU	MS51	NM1120	NM1244	
Application	Single phase	Three phase		

Market for Cooling Fan

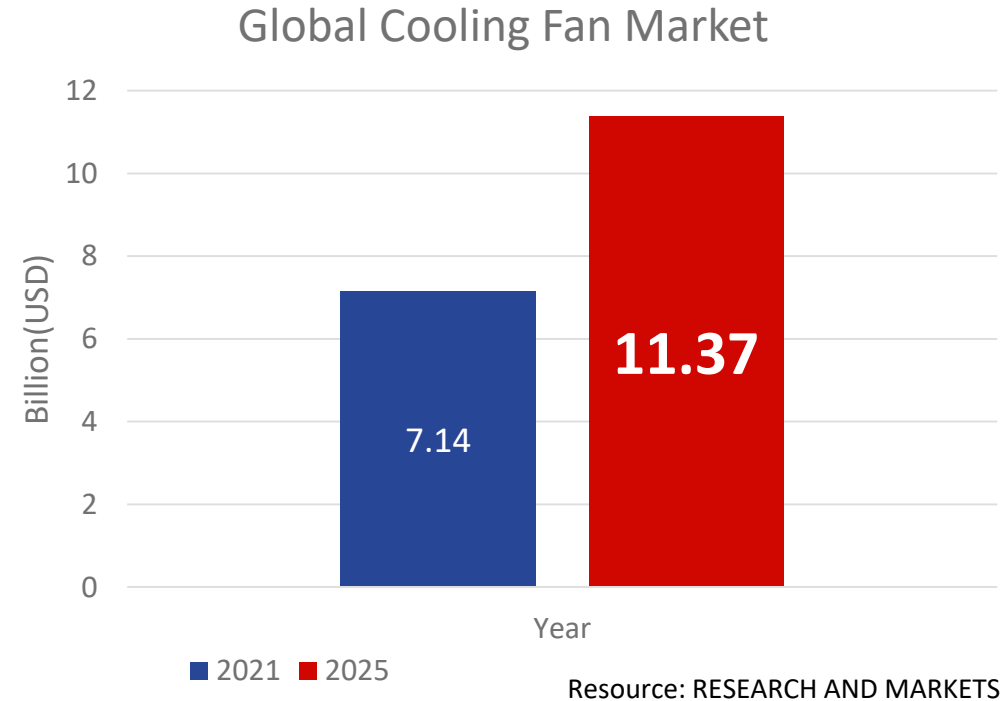
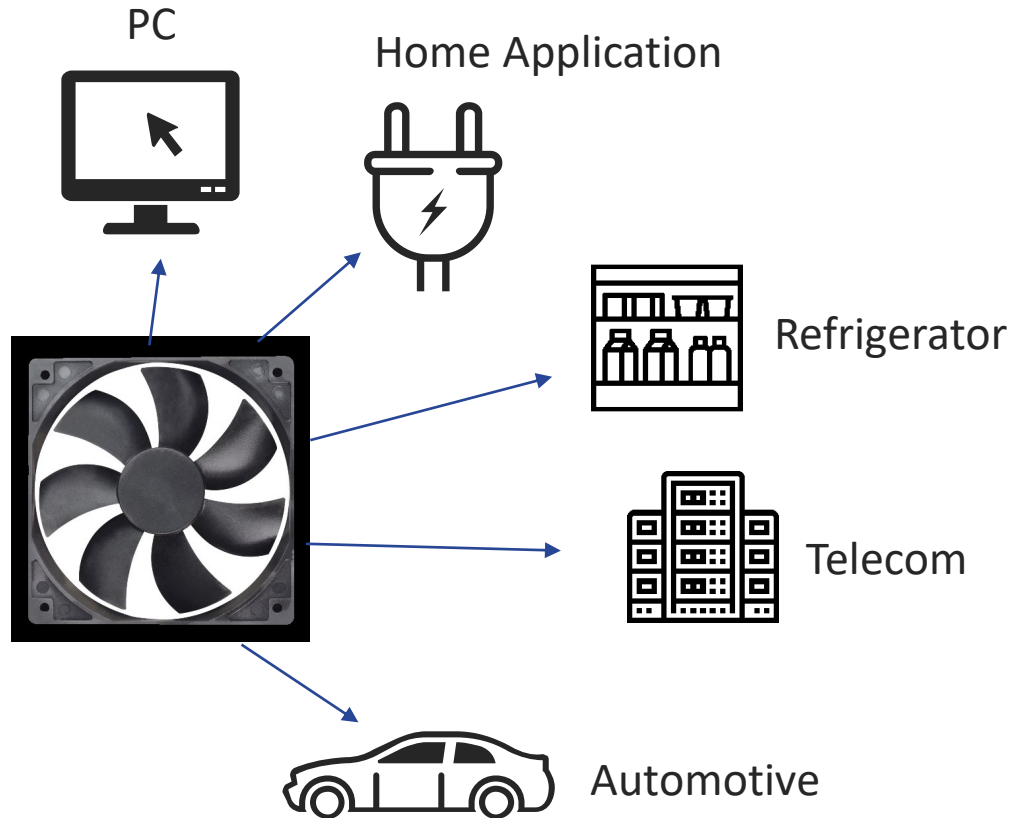

CAGR is about **12.34%**.

NM18002Y

Highlights

- 12V-24V Fan
- PN gate driver
- Supports 4-Wire Programming
- Passive part → Active control unit

Communication
UART/I²C

Detection

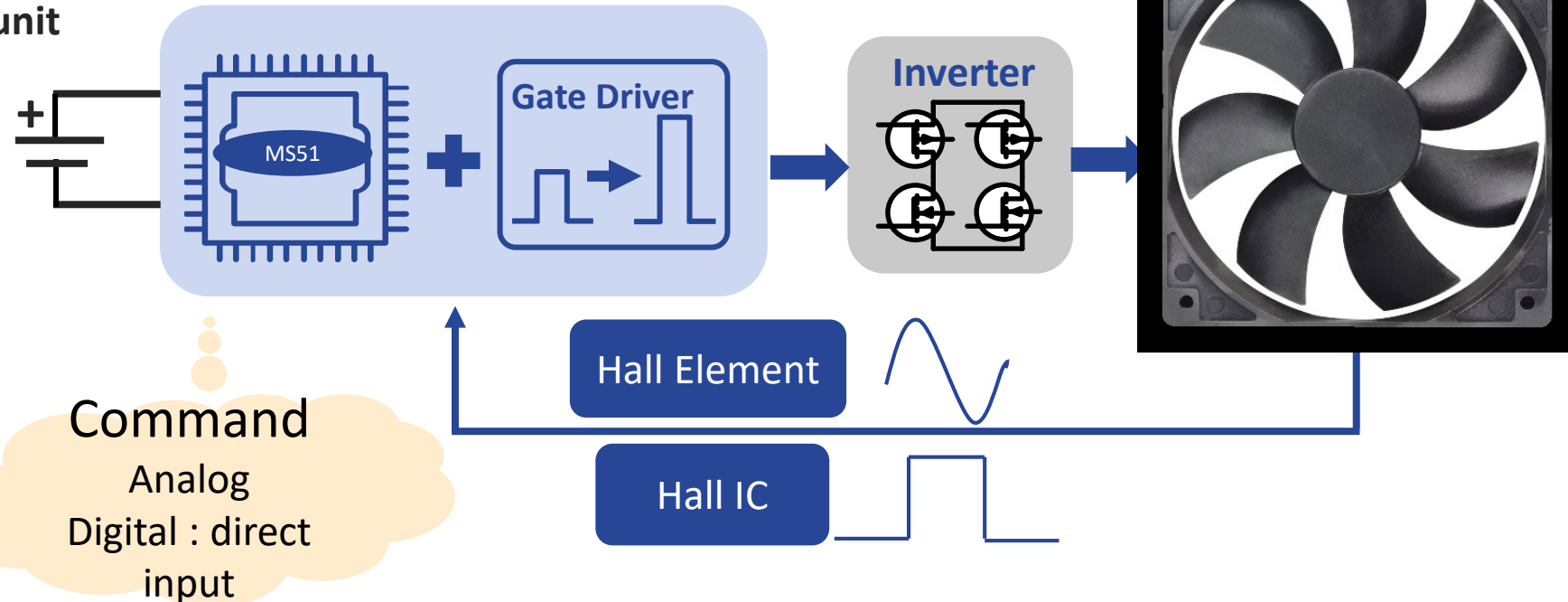
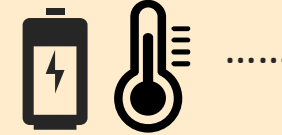

5cm

3cm

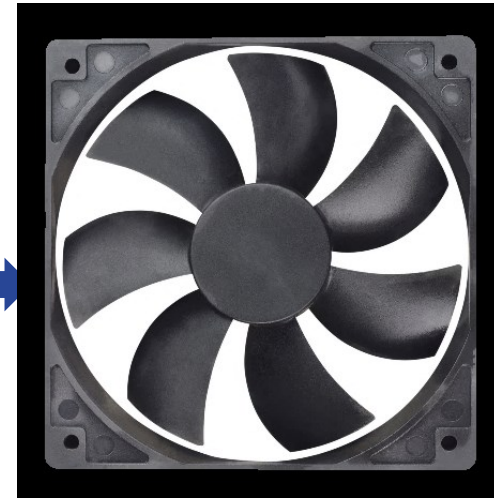

NM18440D

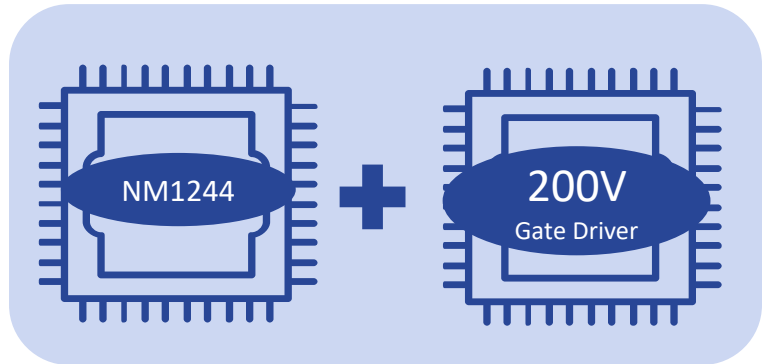

Highlights

- 200V application : 110VAC, 24~96VDC
- LQFP48(7x7)
- Up to 29 GPIO

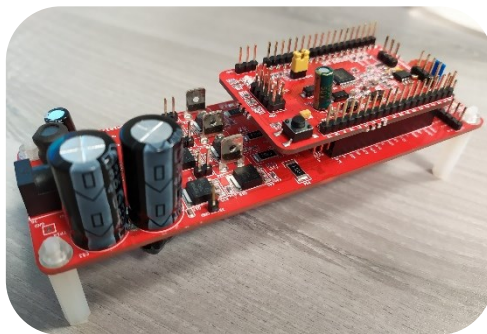

Cooling fan
in
refrigerator

Hand
Drier



Ceiling
fan

Soy-milk
maker



Tools for Development



Tiny Board

NT-NM1200
NT-NM1120
NT-NM1230
NT-NM1240
NT-NM1530

Hardware

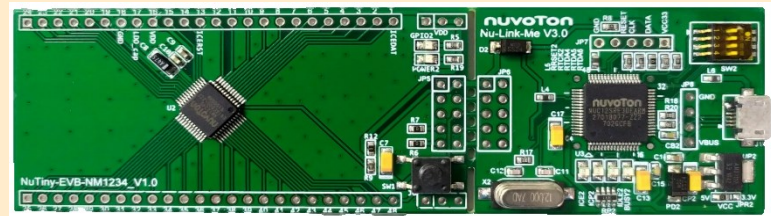

MCU + NuLink

Software

NM1200_BSP_CMSIS
NM1120_BSP_CMSIS
NM1230_BSP_CMSIS
NM1240_BSP_CMSIS
NM1530_BSP_CMSIS

Motor System Board

NK-NM1200L NK-NM1120L
NK-NM1230L NK-NM1240L
NK-NM1530L

NK-NM18107L NK-NM18002
NK-NM18440 NK-NM1817H



MCU + GateDriver +MosFET

NuMotor_NM1200
NuMotor_NM1120
NuMotor_NM1240
NuMotor_NM1230
NuMotor_NM1530
NuMotor_NM18002Y

| We Provide.....



Balanced Product Line



Technical consult



Shipment > 100kk



High quality



Long life cycle



Synchronize with Nuvoton NOW!

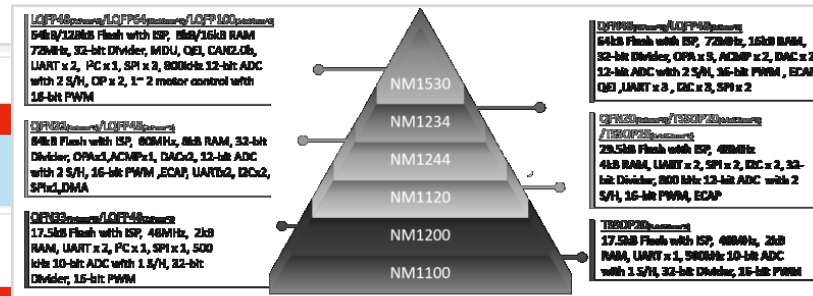

www.nuvoton.com

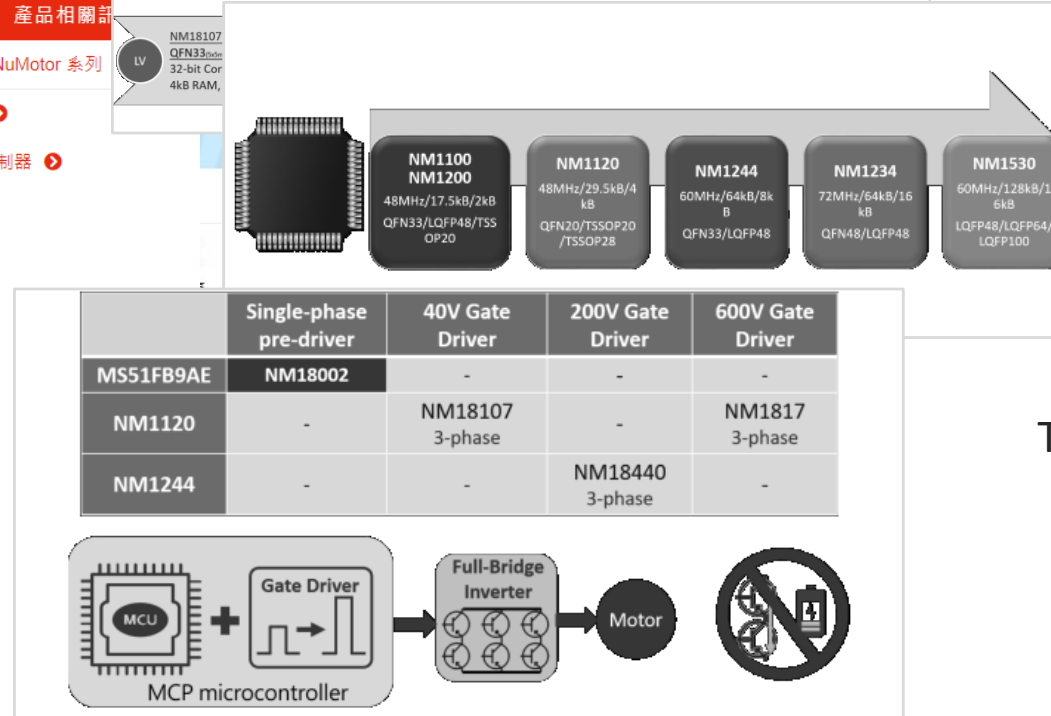

Tools, Datasheets, BSPs, Example Codes, Circuits, Manuals are

Ready!

Joy of innovation
nuvoTon

谢谢

謝謝

Děkuji

Bedankt

Thank you

Kiitos

Merci

Danke

Grazie

ありがとう

감사합니다

Dziękujemy

Obrigado

Спасибо

Gracias

Teşekkür ederim

Cảm ơn